

# E-TES 120 TROUBLESHOOTING

## Table of Contents:

### Light Configurations



Indicates Light is OFF



Indicates Light is ON

#1		Page 2
#2		Page 5
#3		Page 7
#4		Page 8
#5		Page 9
#6		Page 10
#7		Page 11
#8		Page 12
#9		Page 13
#10		Page 14
#11		Page 15
#12		Page 16
#13		Page 17
#14		Page 18
#15		Page 18
#16		Page 19

Wiring Diagrams: Page 20 - 23

# E-TES 120 TROUBLESHOOTING

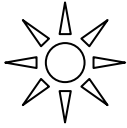

Indicates Light is ON



Indicates Light is OFF

## LIGHT CONFIGURATION #1

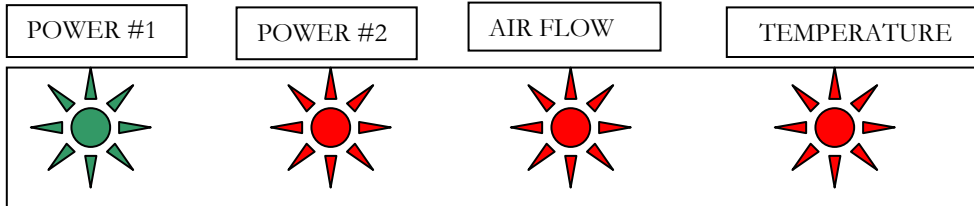

### Step # 1

Usually, when all the lights are ON as shown above, the heater is operating normally and the heating elements are receiving power. If you suspect that the heater is not heating properly even with the lights on, use a clamp-on amp meter to measure the amp draw on each cord of the E-TES 120.

(The actual amp draw will vary with the voltage available and the temperature of the heating elements.)

- If the amp draw of each cord is approximately 16 – 14amps the unit is working OK - Exit.
- If the amp draw of either cord is approximately 8 - 7amps, power from that cord is getting to the heating elements and one element is working, but the other heating element is disconnected or defective - Go to Step #2.
- If the amp draw of either cord is approximately 2-0amps both heating elements on that cord are disconnected or defective - Go to Step #3

### Step # 2

Remove the heating elements and check the wiring which connects the elements to assure that there is continuity between the elements. Check each of the power terminals to be sure there is no continuity to ground. The front two elements are connected to Cord #1. The back two elements are connected to Cord #2. Replace any heating element that has a terminal shorted to ground. Re-install the heating elements into the E-TES 120 and test unit.

- If the amp draw of each cord is approximately 16 - 14amps the unit is working OK - Exit.
- If the amp draw of either cord is approximately 8 - 7amps continue with testing.

Check the resistance between the two terminals on each individual heating element. Resistance should be 14.0 – 14.2ohms. Replace any heating elements with resistance readings outside this range. Reconnect heating elements and check to assure that you have continuity between the inside terminals on both heating elements on each cord, but no continuity between the two cords. Then check to be sure there is continuity between the outside terminals on both heating elements. Then check the resistance of the inside & outside terminals it should read approximately 7 ohms. Repair wires as needed to assure that all elements are connected properly and reinstall the elements into the E-TES 120 and test the unit.

- If the amp draw is approximately 16 - 14amps the unit is working OK - Exit.
- If the amp draw is approximately 8 - 7amps return to Step #1 and check everything again or check your incoming voltage. Amperage may read lower if the voltage is less than 115-120volts. Check voltage at source and at GFCI cord plug where it connects to the E-TES unit. Repair cord, repair voltage source or find new circuit as needed to deliver 115-120 volts and repeat testing.

### **Step # 3**

With both power cords connected to the E-TES 120 unit and the air mover on, turn the switch to the ON position.

- If only Power 1 light is ON – Go to Light Configuration #7
- If only Power 1 light & Air Flow light are ON – Go to Light Configuration #3
- If only Power 2 light is ON – Go to Light Configuration #8
- If only Power 2 light & Temperature light are ON – Go to Light Configuration #4
- If all the lights are on, check the voltage between terminal #4 of the terminal block where the neutral wire to the front heating elements is connected and terminal #4 of relay #1 where the hot wire to the front heating elements .
- Voltage found – Repair wires as needed to restore power to the heating elements and proceed to Step #4.
- No voltage found – With both power cords connected to the E-TES 120 unit, the air mover on and the E-TES switch on, since the Power 1 light is on, there must be a good neutral connection at terminal #4 of the terminal block. First check to see if voltage is being sent to activate the relay. Check for power between the wires connecting to terminal #0 & #1 of relay #1.
  - No voltage found – If the airflow light is ON, there must be power flowing through the airflow switch to the airflow light. With both power cords connected to the E-TES 120 unit, the air mover on and the E-TES switch on, since the Power 1 light is on, there must be a good neutral connection at terminal #4 of the terminal block and a hot connection to terminal #3. First check to find where the break in voltage is between the terminal block and the relay. Using terminal #4 of the terminal block as your neutral connection test for power at the hot wire connected to terminal #0 of relay #1.
    - Voltage found – Return to Step #1
    - No voltage found – Repair or replace the hot wire from the E-TES switch to the relay as needed to restore power to terminal #0 and return to Step #1.
  - Voltage found - Using terminal #4 of the terminal block as your neutral connection, test for power at terminal #2 of relay #1 where the hot wire from terminal #6 of Relay #2 is connected.
    - Voltage found – Replace the relay and return to the beginning of Step #2.
    - No voltage found – Using terminal #4 of the terminal block as your neutral connection, test for power at terminal #6 of relay #2 where the other end of the hot wire to terminal #2 of Relay #1 is connected.
      - Voltage found – Repair or replace the wire from terminal #6 of relay #2 as needed to restore power to terminal #2 of Relay #1 and return to the beginning of Step #2.
      - No voltage found – Check to see if voltage is being sent to activate the relay. Check for power between the wires connecting to terminal #0 & #1 of relay #2.
        - No voltage found – Proceed to Step #3A.
        - Voltage found - Using terminal #4 of the terminal block as your neutral connection, test for power at terminal #8 of relay #2 where the hot wire from terminal #3 of the terminal block is connected.
          - Voltage found – Replace the relay and return to the beginning of Step #2.
          - No voltage found - Since the Power 1 light is on, there must be a good neutral connection at terminal #4 of the terminal block and a good hot connection to terminal #3 of the terminal block. Repair or replace the wire from terminal #3 of the terminal block to terminal #8 of Relay #2 as needed to restore power to terminal #8 of Relay #2 and return to the beginning of Step #2.

### **Step # 3A**

The power that turns on the Temperature light also provides the power to activate the relay. If the temperature light is on, but there is no power at terminal #1 & terminal #0 of relay #2, use terminal #2 of the terminal block as your neutral connection and test for power at the hot wire connected to terminal #1 of relay #2.

- Voltage found – Continue with testing.
- No voltage found – Repair or replace the hot wire from the connection points with the temperature light, Power 2 light and E-TES switch to the relay as needed to restore power to terminal #1 of relay #2 and continue with testing.

Retest for power between the hot wire connected to terminal #1 and the neutral wire connected to terminal #0 of relay #2.

- Voltage found – Return to Step #1.
- No voltage found – Repair or replace the neutral wire from the connection point with the temperature light and the 250°F temperature switches and the relay as needed to restore power to terminal #1 of relay #2 and return to Step #1.

### **Step # 4**

Now that you know that power is being supplied to the heating elements, retest the amp draw of each cord. (The actual amp draw will vary with the voltage available and the temperature of the heating elements.)

- If the amp draw of each cord is approximately 16 – 14amps the unit is working OK - Exit.
- If the amp draw of either cord is approximately 8 - 7amps, power from that cord is getting to the heating elements and one element is working, but the other heating element is disconnected or defective - Go to Step #2.
- If the amp draw of either cord is approximately 2-0amps both heating elements on that cord are defective – Replace both heating elements and return to Step #1.

## LIGHT CONFIGURATION #2

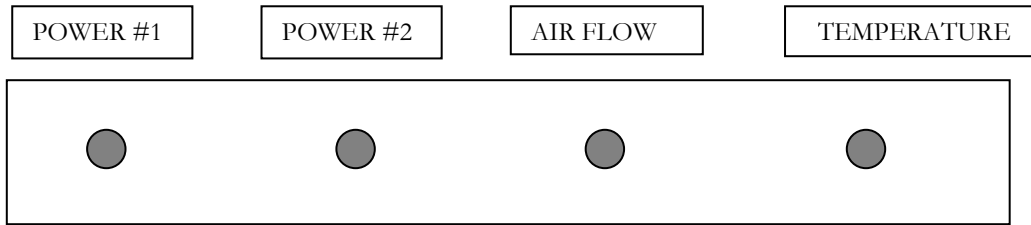

### Step # 1

The power supply from both Power Cord #1 and #2 may have been cut off. Check the 120v circuit breaker for the outlets into which each cord is plugged and reset the GFCI of each cord as needed. Test for power at the 120v outlets and at the receptacle ends on the GFCI cords where they connects to the E-TES to assure that power is getting to the E-TES 120. Once you are sure that there is power being supplied from both power cords, turn the E-TES switch on. Do both the green power lights turn on?

- No both lights stay OFF – Turn the air mover ON. Are any other lights ON?
  - Yes the air flow light is ON - Go to Light Configuration #11.
  - Yes the Temperature light is ON - Go to Light Configuration #10.
  - Yes both the Air Flow & Temperature lights are ON - Go to Light Configuration #12.
  - No – All Light are OFF – Proceed to Step #2.
- No the Power 2 light stays OFF – Turn on the Air Mover. Are any other lights ON?
  - Yes the air flow light is ON – Go to Light Configuration #3.
  - Yes the Temperature light is ON – Go to Light Configuration #13.
  - Yes both the Air Flow & Temperature lights are ON– Go to Light Configuration #14.
  - No only the Power 1 light is ON – Go to Light Configuration #7.
- No the Power 1 light stays OFF – Turn on the air mover. Are any other lights ON?
  - Yes the air flow light is ON – Go to Light Configuration #16.
  - Yes the Temperature light is ON– Go to Light Configuration #4.
  - Yes both the Air Flow & Temperature lights are ON– Go to Light Configuration #15.
  - No only the Power 2 light is ON – Go to Light Configuration #8.
- Yes both lights comes ON – Does the temperature light come ON?
  - Yes – Turn the air mover ON – Does the air flow light come ON?
    - Yes – Go to light configuration #1.
    - No – Go to light configuration #5.
  - No – Turn the air mover ON – Does the air flow light come ON?
    - Yes – Go to light configuration #9
    - No – Go to light configuration #6

### Step # 2

With Power Cord #2 connected to the E-TES 120, test for power at terminal #1 & terminal #2 of the terminal block.

- Voltage found – Continue with testing.
- No voltage found – Repair wires from the flanged plug and or replace the flanged plug to restore the power to terminal #1 & terminal #2 of the terminal block and continue with testing.

Using terminal #2 as your neutral connection test for power at the terminal of the E-TES switch where the hot wire from terminal #1 is connected.

- Voltage found – Continue with testing.
- No voltage found – Repair or replace the hot wire from terminal #1 to the E-TES switch as needed to restore power to the E-TES switch and continue with testing.

Using terminal #2 as your neutral connection, turn the E-TES switch ON and test for power at the terminal of the E-TES switch where the hot wire to the Power #2 light is connected.

- Voltage found – Continue with testing.
- No voltage found – Replace the E-TES switch and continue with testing.

Test for power at the two wires connected to the Power #2 Light.

- Voltage found – Replace the Power #2 light and proceed to Step #3.
- No voltage found – Repair the hot wire from the E-TES switch to the Power #2 light and the neutral wire from terminal #2 of terminal block to the light as needed to restore power to the light when the E-TES switch is ON. Turn the E-TES switch ON. Does the Power #2 light turn ON?
  - Yes the light is ON – Proceed to Step #3.
  - No the light is OFF – Replace the light and proceed to Step #3

### **Step # 3**

With Power Cord #1 connected to the E-TES 120, test for power at terminal #3 & terminal #4 of the terminal block.

- Voltage found – Continue with testing.
- No voltage found – Repair wires from the flanged plug and or replace the flanged plug to restore the power to terminal #3 & terminal #4 of the terminal block and continue with testing.

Using terminal #4 as your neutral connection test for power at the terminal of the E-TES switch where the hot wire from terminal #3 is connected.

- Voltage found – Continue with testing.
- No voltage found – Repair or replace the hot wire from terminal #3 to the E-TES switch as needed to restore power to the E-TES switch and continue with testing.

Using terminal #4 as your neutral connection, turn the E-TES switch ON and test for power at the terminal of the E-TES switch where the hot wire to the Power #1 light is connected.

- Voltage found – Continue with testing.
- No voltage found – Replace the E-TES switch and continue with testing.

Test for power at the two wires connected to the Power #1 Light.

- Voltage found – Replace the Power #1 light and return to Step #1.
- No voltage found – Repair the hot wire from the E-TES switch to the Power #1 light and the neutral wire from terminal #4 of terminal block to the light as needed to restore power to the light when the E-TES switch is ON. Turn the E-TES switch ON. Does the Power #1 light turn ON?
  - Yes the light is ON – Return to Step #1.
  - No the light is OFF – Replace the light and return to Step #1

## LIGHT CONFIGURATION #3

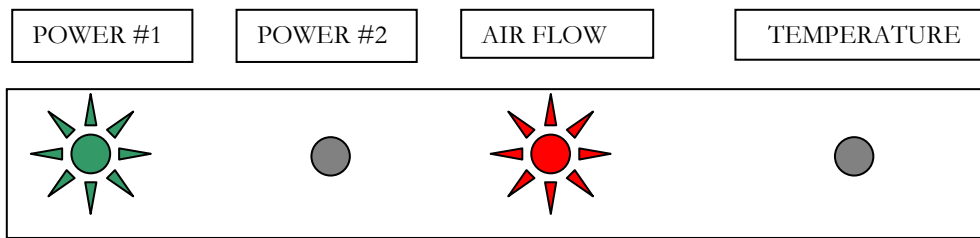

### **Step # 1**

The power supply from Power Cord #2 may have been cut off. Check the 120v circuit breaker for the outlet into which the cord is plugged and reset the GFCI as needed. Test for power at the 120v outlet and at the receptacle end on the GFCI cord where it connects to the E-TES to assure that power is getting to the E-TES 120. Once you are sure that there is power being supplied from power cord #2, turn the E-TES switch on. Does the green power #2 light turn on?

- No the light stays OFF – Continue with testing.
- Yes the light comes ON – Does the red Temperature light turn on?
  - No – Go to Light Configuration #9.
  - Yes – Go to Light Configuration #1.

Test for power at terminal #1 & terminal #2 of the terminal block.

- Voltage found – Continue with testing.
- No voltage found – Repair wires from the flanged plug and or replace the flanged plug to restore the power to terminal #1 & terminal #2 of the terminal block and continue with testing.

Using terminal #2 as your neutral connection test for power at the terminal of the E-TES switch where the hot wire from terminal #1 is connected.

- Voltage found – Continue with testing.
- No voltage found – Repair or replace the hot wire from terminal #1 to the E-TES switch as needed to restore power to the E-TES switch and continue with testing.

Using terminal #2 as your neutral connection, turn the E-TES switch ON and test for power at the terminal of the E-TES switch where the hot wire to the Power #2 light is connected.

- Voltage found – Continue with testing.
- No voltage found – Replace the E-TES switch and continue with testing.

Test for power at the two wires connected to the Power #2 Light.

- Voltage found – Replace the Power #2 light and return to the beginning of Step #1.
- No voltage found – Repair the hot wire from the E-TES switch to the Power #2 light and the neutral wire from terminal #2 of terminal block to the light as needed to restore power to the light when the E-TES switch is ON. Turn the E-TES switch ON. Does the Power #2 light turn ON?
  - Yes the light is ON – Go to Light Configuration #1.
  - No the light is OFF – Replace the light and return to the beginning of Step #1

## LIGHT CONFIGURATION #4

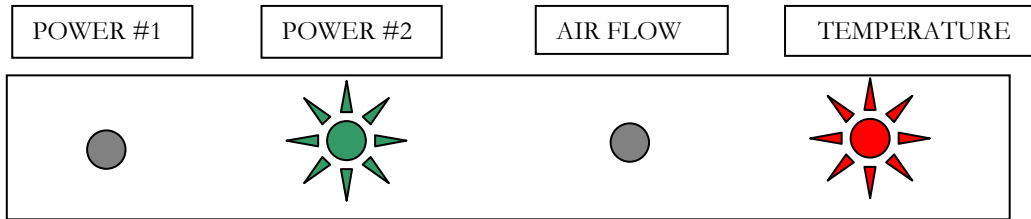

### Step # 1

The power supply from Power Cord #1 may have been cut off. Check the 120v circuit breaker for the outlet into which the cord is plugged and reset the GFCI as needed. Test for power at the 120v outlet and at the receptacle end on the GFCI cord where it connects to the E-TES to assure that power is getting to the E-TES 120. Once you are sure that there is power being supplied from power cord #1, turn the E-TES switch on. Does the green power #1 light turn on?

- No the light stays OFF – Continue with testing.
- Yes the light comes ON – Turn the air mover ON. Does the red Air Flow light turn on?
  - No – Go to Light Configuration #5.
  - Yes – Go to Light Configuration #1.

Test for power at terminal #3 & terminal #4 of the terminal block.

- Voltage found – Continue with testing.
- No voltage found – Repair wires from the flanged plug and or replace the flanged plug to restore the power to terminal #3 & terminal #4 of the terminal block and continue with testing.

Using terminal #4 as your neutral connection, test for power at the terminal of the E-TES switch where the hot wire from terminal #3 is connected.

- Voltage found – Continue with testing.
- No voltage found – Repair or replace the hot wire from terminal #3 to the E-TES switch as needed to restore power to the E-TES switch and continue with testing.

Using terminal #4 as your neutral connection, turn the E-TES switch ON and test for power at the terminal of the E-TES switch where the hot wire to the Power #1 light is connected.

- Voltage found – Continue with testing.
- No voltage found – Replace the E-TES switch and continue with testing.

Test for power at the two wires connected to the Power #1 Light.

- Voltage found – Replace the Power #1 light and return to the beginning of Step #1.
- No voltage found – Repair the hot wire from the E-TES switch to the Power #1 light and the neutral wire from terminal #4 of terminal block to the light as needed to restore power to the light when the E-TES switch is ON. Turn the E-TES switch ON. Does the Power #1 light turn ON?
  - No the light is OFF – Replace the light and return to the beginning of Step #1
  - Yes the light is ON – Turn the Air Mover ON. Does the Air Flow light turn ON?
    - Yes - Go to Light Configuration #1.
    - No – Go to Light Configuration #5.



## LIGHT CONFIGURATION #5

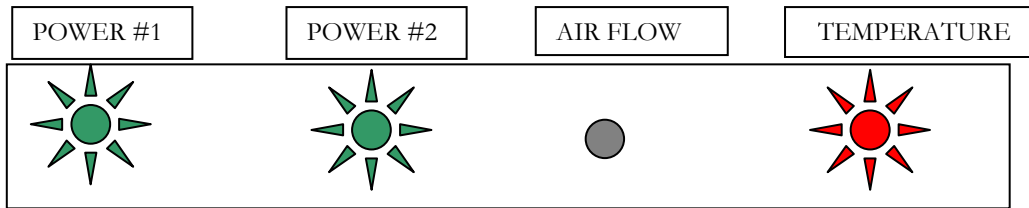

### Step # 1

With both power cords connected to the E-TES 120 unit, the air mover on and the E-TES switch on, since the Power 1 light is on, there must be a good neutral connection at terminal #4 of the terminal block and a hot connection to terminal #3. First check the voltage between the terminal block and relay #1. Using terminal #4 of the terminal block as your neutral connection test for power at the hot wire connected to terminal #0 of relay #1.

- Voltage found – Continue with testing.
- No voltage found – Repair or replace the hot wire from the E-TES switch to the relay as needed to restore power to terminal #0 and continue with testing.

Using terminal #3 of the terminal block as your hot connection test for power at the neutral wire from terminal #4 of the terminal block where it connects to the air flow switch.

- Voltage found – Continue with testing.
- No voltage found – Repair or replace the neutral wire from terminal #4 of the terminal block to the air flow switch as needed to restore power to the air flow switch and continue with testing.

Test the air flow switch. With no air flow there should not be any continuity between the COM terminal and the NO terminal. (We do not use the NC terminal.) When air flow is present and the paddle is pushed to activate the switch, there should now be continuity between the COM terminal and the NO terminal. Replace the switch as needed to assure that the switch is operating properly.

Make sure the air flow switch is wired correctly. One wire is connected to the COM terminal and one wire is connected to the NO terminal. The NC terminal is unused. When you have the switch properly connected, use terminal #3 of the terminal block as your hot connection and test for power at the neutral wires connecting to terminal #1 of relay #1.

- No voltage found – Repair or replace the neutral wire from the air flow switch to terminal #1 of relay #1 as needed to restore power to the relay and continue with testing.
- Voltage found – Continue with testing.

Test for power at the two wires connected to the Air Flow Light.

- Voltage found – Replace the Air Flow light.
- No voltage found – Repair the hot wire from the E-TES switch to the air flow light and the neutral wire from terminal #1 of Relay #1 as needed to restore power to the light when both cords are connected, the E-TES switch is ON and the air mover is ON.
  - If the light is ON – Go to Light Configuration #1.
  - If the light is OFF – Replace the light and return to the beginning of Step #1

## LIGHT CONFIGURATION #6

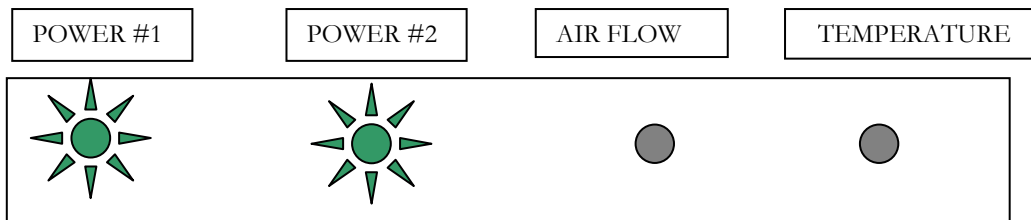

### **Step # 1**

With both power cords connected to the E-TES 120 unit, the air mover on and the E-TES switch on, since the Power 1 light is on, there must be a good neutral connection at terminal #4 of the terminal block and a hot connection to terminal #3. First check the voltage between the terminal block and relay #1. Using terminal #4 of the terminal block as your neutral connection test for power at the hot wire connected to terminal #0 of relay #1.

- Voltage found – Continue with testing.
- No voltage found – Repair or replace the hot wire from the E-TES switch to the relay as needed to restore power to terminal #0 and continue with testing.

Using terminal #3 of the terminal block as your hot connection test for power at the neutral wire from terminal #4 of the terminal block where it connects to the air flow switch.

- Voltage found – Continue with testing.
- No voltage found – Repair or replace the neutral wire from terminal #4 of the terminal block to the air flow switch as needed to restore power to the air flow switch and continue with testing.

Test the air flow switch. With no air flow there should not be any continuity between the COM terminal and the NO terminal. (We do not use the NC terminal.) When air flow is present and the paddle is pushed to activate the switch, there should now be continuity between the COM terminal and the NO terminal. Replace the switch as needed to assure that the switch is operating properly.

Make sure the air flow switch is wired correctly. One wire is connected to the COM terminal and one wire is connected to the NO terminal. The NC terminal is unused. When you have the switch properly connected, use terminal #3 of the terminal block as your hot connection and test for power at the neutral wires connecting to terminal #1 of relay #1.

- No voltage found – Repair or replace the neutral wire from the air flow switch to terminal #1 of relay #1 as needed to restore power to the relay and continue with testing.
- Voltage found – Continue with testing.

Test for power at the two wires connected to the Air Flow Light.

- Voltage found – Replace the Air Flow light.
- No voltage found – Repair the hot wire from the E-TES switch to the air flow light and the neutral wire from terminal #1 of Relay #1 as needed to restore power to the light when both cords are connected, the E-TES switch is ON and the air mover is ON.
  - If the light is ON – Go to Light Configuration #9.
  - If the light is OFF – Replace the light and retest.
    - If the light is ON – Go to Light Configuration #9.
    - The light is OFF - Return to the beginning of Step #1 and check everything again.

## LIGHT CONFIGURATION #7

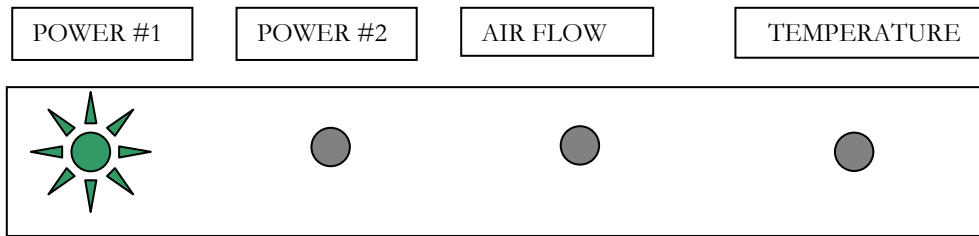

### **Step # 1**

The power supply from Power Cord #2 may have been cut off. Check the 120v circuit breaker for the outlet into which the cord is plugged and reset the GFCI as needed. Test for power at the 120v outlet and at the receptacle end on the GFCI cord where it connects to the E-TES to assure that power is getting to the E-TES 120. Once you are sure that there is power being supplied from power cord #2, turn the E-TES switch on. Does the green power #2 light turn on?

- No the light stays OFF – Continue with testing.
- Yes the light comes ON – Does the red Temperature light turn on?
  - No – Go to Light Configuration #6.
  - Yes – Turn the Air Mover ON. Does the Air Flow light turn ON?
    - No - Go to Light Configuration #5.
    - Yes – Go to Light Configuration #1.

Test for power at terminal #1 & terminal #2 of the terminal block.

- Voltage found – Continue with testing.
- No voltage found – Repair wires from the flanged plug and or replace the flanged plug to restore the power to terminal #1 & terminal #2 of the terminal block and return to the beginning of Step #1.

Using terminal #2 as your neutral connection, test for power at the terminal of the E-TES switch where the hot wire from terminal #1 is connected.

- Voltage found – Continue with testing.
- No voltage found – Repair or replace the hot wire from terminal #1 to the E-TES switch as needed to restore power to the E-TES switch and continue with testing.

Using terminal #2 as your neutral connection, turn the E-TES switch ON and test for power at the terminal of the E-TES switch where the hot wire to the Power #2 light is connected.

- Voltage found – Continue with testing.
- No voltage found – Replace the E-TES switch and continue with testing.

Test for power at the two wires connected to the Power #2 Light.

- Voltage found – Replace the Power #2 light and return to the beginning of Step #1.
- No voltage found – Repair the hot wire from the E-TES switch to the Power #2 light and the neutral wire from terminal #2 of terminal block to the light as needed to restore power to the light when the E-TES switch is ON. Turn the E-TES switch ON. Does the Power #2 light turn ON?
  - No the light is OFF – Replace the light and return to the beginning of Step #1
  - Yes the light is ON – Does the Temperature light come ON?
    - Yes – Go to Light Configuration #5
    - No – Go to Light Configuration #6.

## LIGHT CONFIGURATION #8

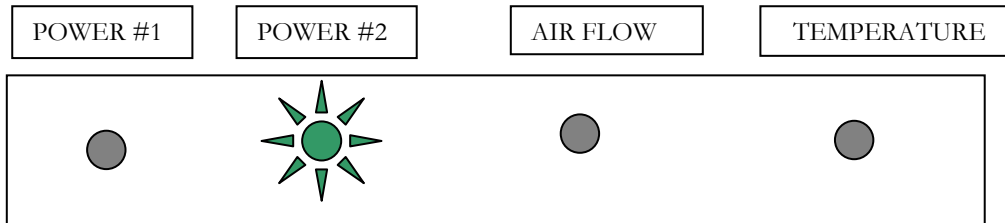

### Step # 1

The power supply from Power Cord #1 may have been cut off. Check the 120v circuit breaker for the outlet into which the cord is plugged and reset the GFCI as needed. Test for power at the 120v outlet and at the receptacle end on the GFCI cord where it connects to the E-TES to assure that power is getting to the E-TES 120. Once you are sure that there is power being supplied from power cord #1, turn the E-TES switch on. Does the green power #1 light turn on?

- No the light stays OFF – Continue with testing.
- Yes the light comes ON – Turn the air mover ON. Does the red Air Flow light turn on?
  - No – Go to Light Configuration #6.
  - Yes – Go to Light Configuration #9.

Test for power at terminal #3 & terminal #4 of the terminal block.

- Voltage found – Continue with testing.
- No voltage found – Repair wires from the flanged plug and or replace the flanged plug to restore the power to terminal #3 & terminal #4 of the terminal block and continue with testing.

Using terminal #4 as your neutral connection, test for power at the terminal of the E-TES switch where the hot wire from terminal #3 is connected.

- Voltage found – Continue with testing.
- No voltage found – Repair or replace the hot wire from terminal #3 to the E-TES switch as needed to restore power to the E-TES switch and continue with testing.

Using terminal #4 as your neutral connection, turn the E-TES switch ON and test for power at the terminal of the E-TES switch where the hot wire to the Power #1 light is connected.

- Voltage found – Continue with testing.
- No voltage found – Replace the E-TES switch and continue with testing.

Test for power at the two wires connected to the Power #1 Light.

- Voltage found – Replace the Power #1 light and return to the beginning of Step #1.
- No voltage found – Repair the hot wire from the E-TES switch to the Power #1 light and the neutral wire from terminal #4 of terminal block to the light as needed to restore power to the light when the E-TES switch is ON. Turn the E-TES switch ON. Does the Power #1 light turn ON?
  - No the light is OFF – Replace the light and return to the beginning of Step #1
  - Yes the light is ON – Turn the Air Mover ON. Does the Air Flow light turn ON?
    - Yes - Go to Light Configuration #9.
    - No – Go to Light Configuration #6.

## LIGHT CONFIGURATION #9

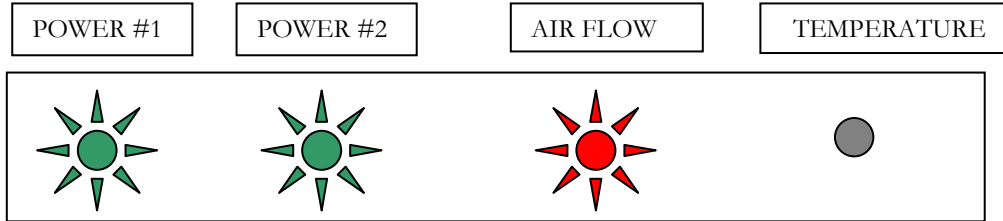

### **Step # 1**

With both power cords connected to the E-TES 120 unit, the air mover on and the E-TES switch on, since the Power 2 light is on, there must be a good neutral connection at terminal #2 of the terminal block and a hot connection to terminal #1. Since the Power lights can be turned on and off with the E-TES switch, the hot connection to the switch and the Power 2 light is OK. First check the voltage between the terminal block and relay #1. Using terminal #2 of the terminal block as your neutral connection, turn the E-TES switch ON and test for power at the hot wire connected to terminal #1 of relay #2.

- Voltage found – Continue with testing.
- No voltage found – Repair or replace the hot wire from the E-TES switch to the relay as needed to restore power to terminal #1 and continue with testing.

Next, Turn the E-TES switch ON and test for power between the hot wire on terminal #1 of relay #2 and the neutral wire on terminal #0 of relay #2.

- Voltage found – Proceed to Step #2.
- No voltage found – Using terminal #1 of the terminal block as your hot connection, test for power at the neutral wire from terminal #2 of the terminal block where it connects to the 200°F temperature switch.
  - Voltage found – Continue with testing.
  - No voltage found – Repair or replace the neutral wire from terminal #2 of the terminal block as needed to restore power to the 200°F temperature switch and continue with testing.

Using terminal #1 of the terminal block as your hot connection, test for power at the outlet terminal of the 200°F temperature switch where the wire to the 250°F temperature switch is connected.

- Voltage found – Continue with testing.
- No voltage found – Replace the 200°F Temperature switch and continue with testing.

Using terminal #1 of the terminal block as your hot connection, test for power at the outlet terminal of the 200°F temperature switch where the wire to the 250°F temperature switch is connected.

- Voltage found – Continue with testing.
- No voltage found – Replace the 200°F Temperature switch and continue with testing.

Remove the jumper wire connecting the two 250°F Temperature switches. Test both 250°F Temperature switches for continuity across their terminals and replace switches as needed to restore continuity through both switches. Examine the jumper wire and repair or replace the jumper wire to assure that you have a good connection between the two 250°F Temperature switches. Reconnect the wire from the 200°F Temperature switch to the first 250°F Temperature switch. Using terminal #1 of the terminal block as your hot connection, test for power at the outlet terminal of the second 250°F Temperature switch.

- Voltage found – Continue with testing.
- No voltage found – Repair or replace the wire from the 200°F Temperature switch to the 250°F Temperature switches as needed to restore power to the outlet of the 250°F Temperature switches and continue with testing.

Reconnect the wire to the outlet of the 250°F Temperature switches. Turn the E-TES switch ON and test for power between the hot wire on terminal #1 of relay #2 and the neutral wire on terminal #0 of relay #2.

- Voltage found – Proceed to Step #2.
- No voltage found – Repair or replace the wire from the 250°F Temperature switch to terminal #0 of relay #2 as needed to restore power to the relay and proceed to Step #2.

### **Step # 2**

Test for power at the two wires connected to the Temperature Light.

- Voltage found – Replace the temperature light and continue with testing.
- No voltage found – Repair the hot wire from the E-TES switch to the Temperature light and the neutral wire connection the 250°F Temperature switches to the light as needed to restore power to the light when the E-TES switch is ON and continue with testing.

Turn the E-TES switch ON. Does the Temperature light turn ON?

- No the light is OFF – Return to the beginning of Step #1 and check everything again.
- Yes the light is ON – Go to Light Configuration #1.

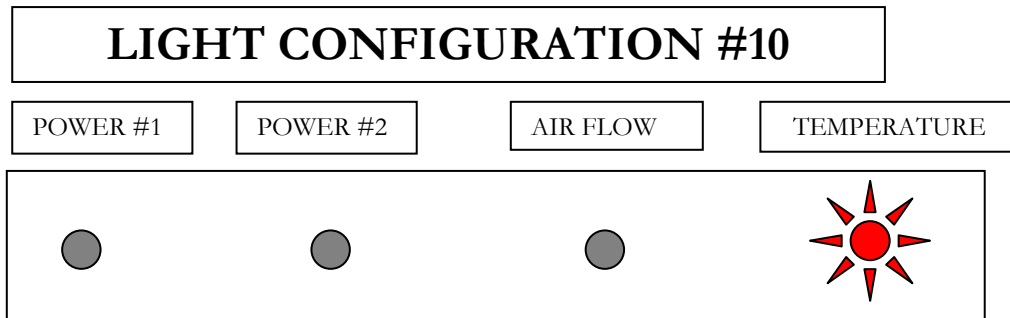

### **Step # 1**

The power supply from Power Cord #1 may have been cut off. Check the 120v circuit breaker for the outlet into which the cord is plugged and reset the GFCI as needed. Test for power at the 120v outlet and at the receptacle end on the GFCI cord where it connects to the E-TES to assure that power is getting to the E-TES 120. Once you are sure that there is power being supplied from power cord #1, turn the E-TES switch on. Does the green power #1 light turn on?

- No the light stays OFF – Continue with testing.
- Yes the light comes ON – Turn the air mover ON. Does the red Air Flow light turn on?
  - No – Go to Light Configuration #13.
  - Yes – Go to Light Configuration #14.

Test for power at terminal #3 & terminal #4 of the terminal block.

- Voltage found – Continue with testing.
- No voltage found – Repair wires from the flanged plug and or replace the flanged plug to restore the power to terminal #3 & terminal #4 of the terminal block and continue with testing.

Using terminal #4 as your neutral connection, test for power at the terminal of the E-TES switch where the hot wire from terminal #3 is connected.

- Voltage found – Continue with testing.
- No voltage found – Repair or replace the hot wire from terminal #3 to the E-TES switch as needed to restore power to the E-TES switch and continue with testing.

Using terminal #4 as your neutral connection, turn the E-TES switch ON and test for power at the terminal of the E-TES switch where the hot wire to the Power #1 light is connected.

- Voltage found – Continue with testing.
- No voltage found – Replace the E-TES switch and continue with testing.

Test for power at the two wires connected to the Power #1 Light.

- Voltage found – Replace the Power #1 light and return to the beginning of Step #1.
- No voltage found – Repair the hot wire from the E-TES switch to the Power #1 light and the neutral wire from terminal #4 of terminal block to the light as needed to restore power to the light when the E-TES switch is ON. Turn the E-TES switch ON. Does the Power #1 light turn ON?
  - No the light is OFF – Replace the light and return to the beginning of Step #1
  - Yes the light is ON – Turn the Air Mover ON. Does the Air Flow light turn ON?
    - Yes - Go to Light Configuration #14.
    - No – Go to Light Configuration #13.

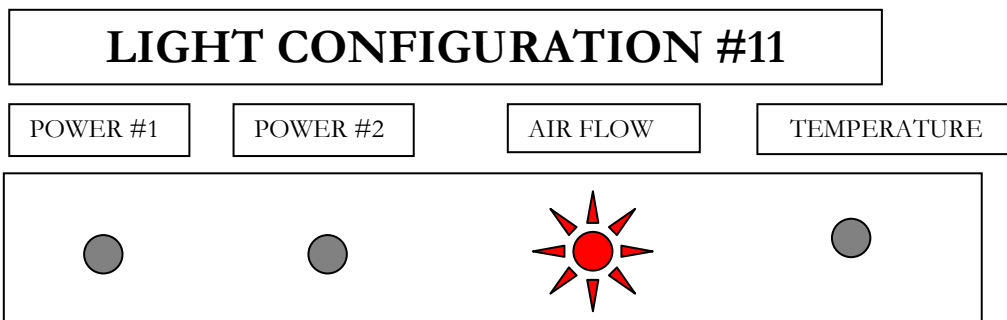

### **Step # 1**

The power supply from Power Cord #2 may have been cut off. Check the 120v circuit breaker for the outlet into which the cord is plugged and reset the GFCI as needed. Test for power at the 120v outlet and at the receptacle end on the GFCI cord where it connects to the E-TES to assure that power is getting to the E-TES 120. Once you are sure that there is power being supplied from power cord #2, turn the E-TES switch on. Does the green power #2 light turn on?

- No the light stays OFF – Continue with testing.
- Yes the light comes ON – Does the red Temperature light turn on?
  - No – Go to Light Configuration #16.
  - Yes – Go to Light Configuration #15.

Test for power at terminal #1 & terminal #2 of the terminal block.

- Voltage found – Continue with testing.
- No voltage found – Repair wires from the flanged plug and or replace the flanged plug to restore the power to terminal #1 & terminal #2 of the terminal block and return to the beginning of Step #1.

Using terminal #2 as your neutral connection, test for power at the terminal of the E-TES switch where the hot wire from terminal #1 is connected.

- Voltage found – Continue with testing.
- No voltage found – Repair or replace the hot wire from terminal #1 to the E-TES switch as needed to restore power to the E-TES switch and continue with testing.

Using terminal #2 as your neutral connection, turn the E-TES switch ON and test for power at the terminal of the E-TES switch where the hot wire to the Power #2 light is connected.

- Voltage found – Continue with testing.
- No voltage found – Replace the E-TES switch and continue with testing.

Test for power at the two wires connected to the Power #2 Light.

- Voltage found – Replace the Power #2 light and return to the beginning of Step #1.
- No voltage found – Repair the hot wire from the E-TES switch to the Power #2 light and the neutral wire from terminal #2 of terminal block to the light as needed to restore power to the light when the E-TES switch is ON. Turn the E-TES switch ON. Does the Power #2 light turn ON?
  - No the light is OFF – Replace the light and return to the beginning of Step #1
  - Yes the light is ON – Does the Temperature light come ON?
    - Yes – Go to Light Configuration #15
    - No – Go to Light Configuration #16.

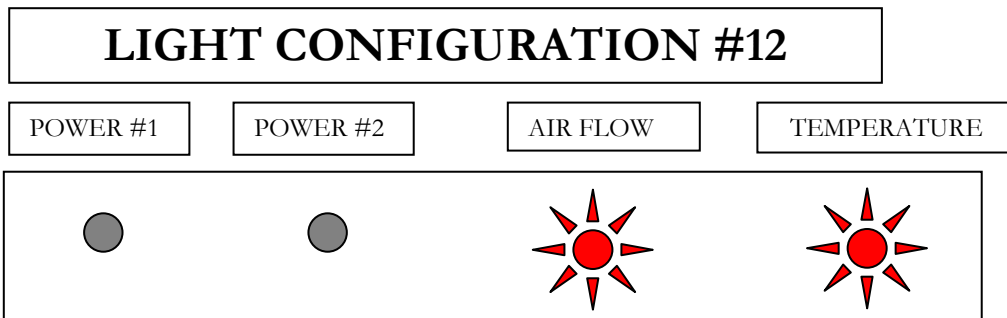

### **Step # 1**

Using terminal #2 as your neutral connection, turn the E-TES switch ON and test for power where the hot wire from the E-TES switch is connected to the Power #2 light.

- Voltage found – Continue with testing.
- No voltage found – Repair or replace the hot wire connection from the E-TES switch to Power #2 light as needed to restore the Hot connection to Power #2 light and continue with testing.

Turn the E-TES switch ON and test for power at the two wires connected to the Power #2 Light.

- Voltage found – Is the light ON?
  - No - Replace the Power #2 light and continue with testing.
  - Yes – Continue with testing.
- No voltage found – Repair the neutral wire from terminal #2 of terminal block to the light as needed to restore power to the light when the E-TES switch is ON. Turn the E-TES switch ON. Does the Power #2 light turn ON?
  - Yes the light is ON – Continue with testing.
  - No the light is OFF – Replace the light Turn the E-TES switch ON. Does the Power #2 light turn ON?
    - No the light is OFF – Return to the beginning of Step #1 and check everything again.
    - Yes the light is ON – Continue with testing.

Using terminal #4 as your neutral connection, turn the E-TES switch ON and test for power where the hot wire from the E-TES switch is connected to the Power #1 light.

- Voltage found – Continue with testing.
- No voltage found – Repair or replace the hot wire connection from the E-TES switch to Power #1 light as needed to restore the Hot connection to Power #1 light and continue with testing.



Turn the E-TES switch ON and test for power at the two wires connected to the Power #1 Light.

- No voltage found – Repair the neutral wire from terminal #2 of terminal block to the light as needed to restore power to the light when the E-TES switch is ON Turn the E-TES switch ON. Does the Power #1 light turn ON?
  - Yes the light is ON – Go to Light Configuration #1.
  - No the light is OFF – Replace the Power #1 light and Turn the E-TES switch ON. Does the Power #2 light turn ON?
    - No the light is OFF – Return to the beginning of Step #1 and test everything again.
    - Yes the light is ON – Go to Light Configuration #1.
- Voltage found – Is the Power #1 light ON?
  - Yes – Go to Light Configuration #1.
  - No - Replace the Power #1 light and Turn the E-TES switch ON. Does the Power #2 light turn ON?
    - No the light is OFF – Return to the beginning of Step #1 and test everything again.
    - Yes the light is ON – Go to Light Configuration #1.

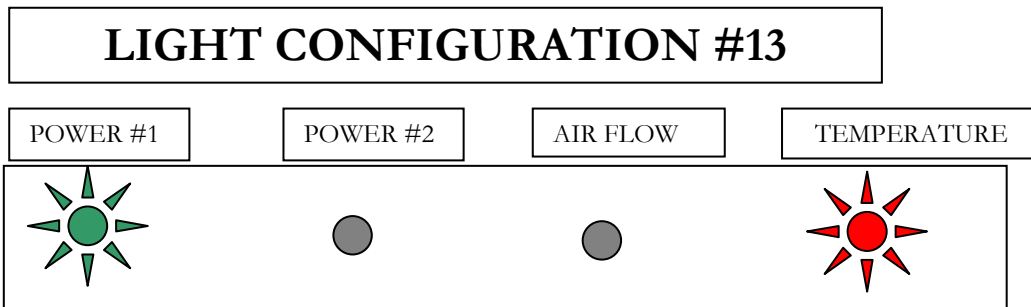

### **Step # 1**

Using terminal #2 as your neutral connection, turn the E-TES switch ON and test for power where the hot wire from the E-TES switch is connected to the Power #2 light.

- Voltage found – Continue with testing.
- No voltage found – Repair or replace the hot wire connection from the E-TES switch to Power #2 light as needed to restore the Hot connection to Power #2 light and continue with testing.

Turn the E-TES switch ON and test for power at the two wires connected to the Power #2 Light.

- Voltage found – Is the light ON?
  - No - Replace the Power #2 light and continue with testing.
  - Yes – Continue with testing.
- No voltage found – Repair the neutral wire from terminal #2 of terminal block to the light as needed to restore power to the light when the E-TES switch is ON. Turn the E-TES switch ON. Does the Power #2 light turn ON?
  - Yes the light is ON – Go to Light Configuration #5.
  - No the light is OFF – Replace the light Turn the E-TES switch ON. Does the Power #2 light turn ON?
    - No the light is OFF – Return to the beginning of Step #1 and check everything again.
    - Yes the light is ON – Go to Light Configuration #5.

## LIGHT CONFIGURATION #14



### Step #1

Using terminal #2 as your neutral connection, turn the E-TES switch ON and test for power where the hot wire from the E-TES switch is connected to the Power #2 light.

- Voltage found – Continue with testing.
- No voltage found – Repair or replace the hot wire connection from the E-TES switch to Power #2 light as needed to restore the Hot connection to Power #2 light and continue with testing.

Turn the E-TES switch ON and test for power at the two wires connected to the Power #2 Light.

- Voltage found – Is the light ON?
  - No - Replace the Power #2 light and continue with testing.
  - Yes – Continue with testing.
- No voltage found – Repair the neutral wire from terminal #2 of terminal block to the light as needed to restore power to the light when the E-TES switch is ON. Turn the E-TES switch ON. Does the Power #2 light turn ON?
  - Yes the light is ON – Go to Light Configuration #1.
  - No the light is OFF – Replace the light Turn the E-TES switch ON. Does the Power #2 light turn ON?
    - No the light is OFF – Return to the beginning of Step #1 and check everything again.
    - Yes the light is ON – Go to Light Configuration #1.

## LIGHT CONFIGURATION #15

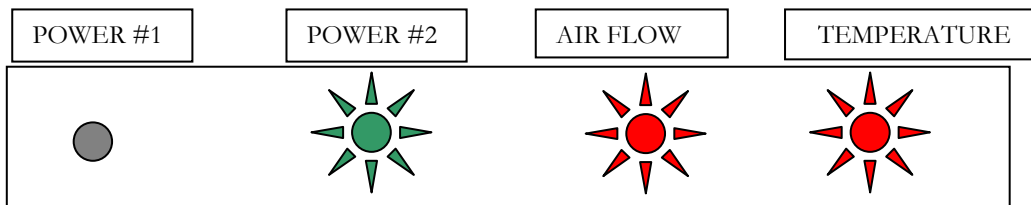

### Step #1

Using terminal #4 as your neutral connection, turn the E-TES switch ON and test for power where the hot wire from the E-TES switch is connected to the Power #1 light.

- Voltage found – Continue with testing.
- No voltage found – Repair or replace the hot wire connection from the E-TES switch to Power #1 light as needed to restore the Hot connection to Power #1 light and continue with testing.

Turn the E-TES switch ON and test for power at the two wires connected to the Power #1 Light.

- No voltage found – Repair the neutral wire from terminal #2 of terminal block to the light as needed to restore power to the light when the E-TES switch is ON Turn the E-TES switch ON. Does the Power #1 light turn ON?
  - Yes the light is ON – Go to Light Configuration #1.
  - No the light is OFF – Replace the Power #1 light and Turn the E-TES switch ON. Does the Power #2 light turn ON?
    - No the light is OFF – Return to the beginning of Step #1 and test everything again.
    - Yes the light is ON – Go to Light Configuration #1.
- Voltage found – Is the Power #1 light ON?
  - Yes – Go to Light Configuration #1.
  - No - Replace the Power #1 light and Turn the E-TES switch ON. Does the Power #2 light turn ON?
    - No the light is OFF – Return to the beginning of Step #1 and test everything again.
    - Yes the light is ON – Go to Light Configuration #1.

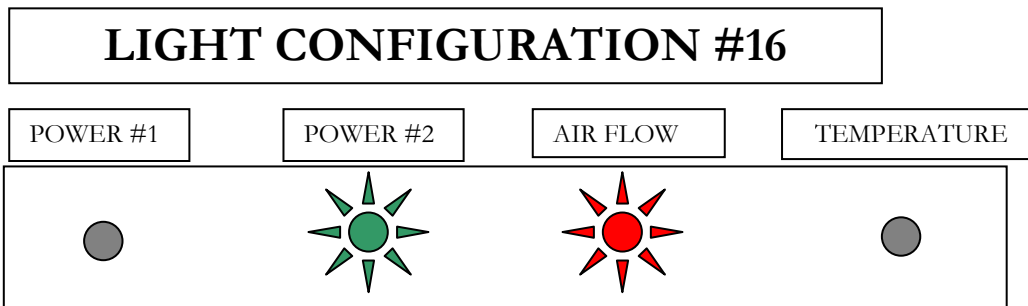

### **Step #1**

Using terminal #4 as your neutral connection, turn the E-TES switch ON and test for power where the hot wire from the E-TES switch is connected to the Power #1 light.

- Voltage found – Continue with testing.
- No voltage found – Repair or replace the hot wire connection from the E-TES switch to Power #1 light as needed to restore the Hot connection to Power #1 light and continue with testing.

Turn the E-TES switch ON and test for power at the two wires connected to the Power #1 Light.

- No voltage found – Repair the neutral wire from terminal #2 of terminal block to the light as needed to restore power to the light when the E-TES switch is ON Turn the E-TES switch ON. Does the Power #1 light turn ON?
  - Yes the light is ON – Go to Light Configuration #9.
  - No the light is OFF – Replace the Power #1 light and Turn the E-TES switch ON. Does the Power #2 light turn ON?
    - No the light is OFF – Return to the beginning of Step #1 and test everything again.
    - Yes the light is ON – Go to Light Configuration #9.
- Voltage found – Is the Power #1 light ON?
  - Yes – Go to Light Configuration #9.
  - No - Replace the Power #1 light and Turn the E-TES switch ON. Does the Power #2 light turn ON?
    - No the light is OFF – Return to the beginning of Step #1 and test everything again.
    - Yes the light is ON – Go to Light Configuration #9.

# E-TES 120 WIRING – POWER CORD 1

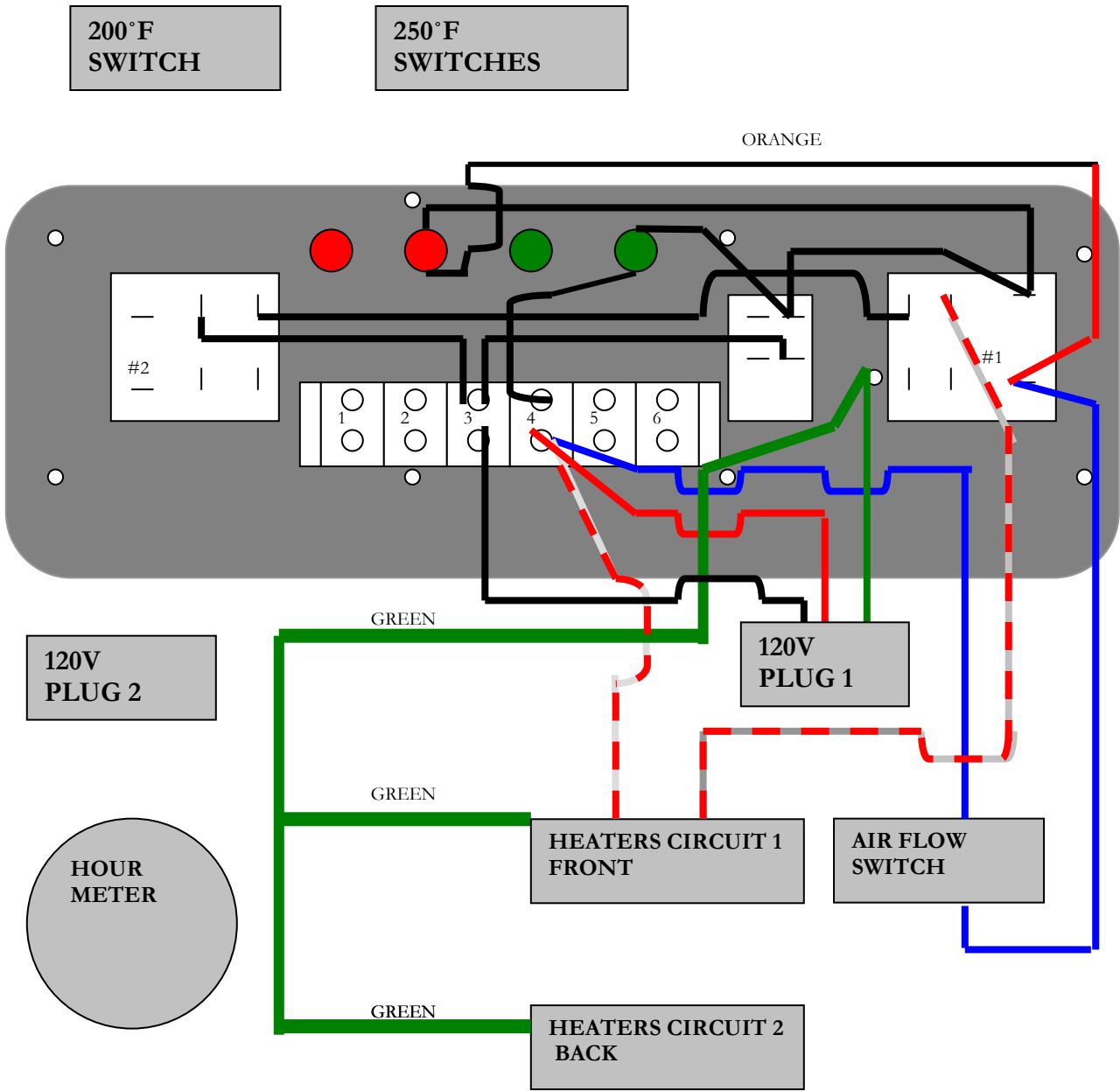

RELAY #2

#1	#8	#6
#0	#4	#2

Relay #1 coil – 120vac  
 Relay #2 coil – 120vac  
 (Coil Terminals are #1 & #0)

Both relays are: DPST - NO

RELAY #1

#2	#4	#0
#6	#8	#1

# E-TES 120 WIRING – POWER CORD 2

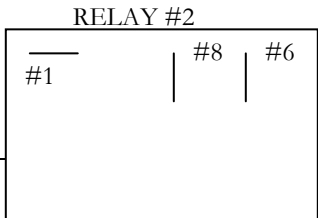
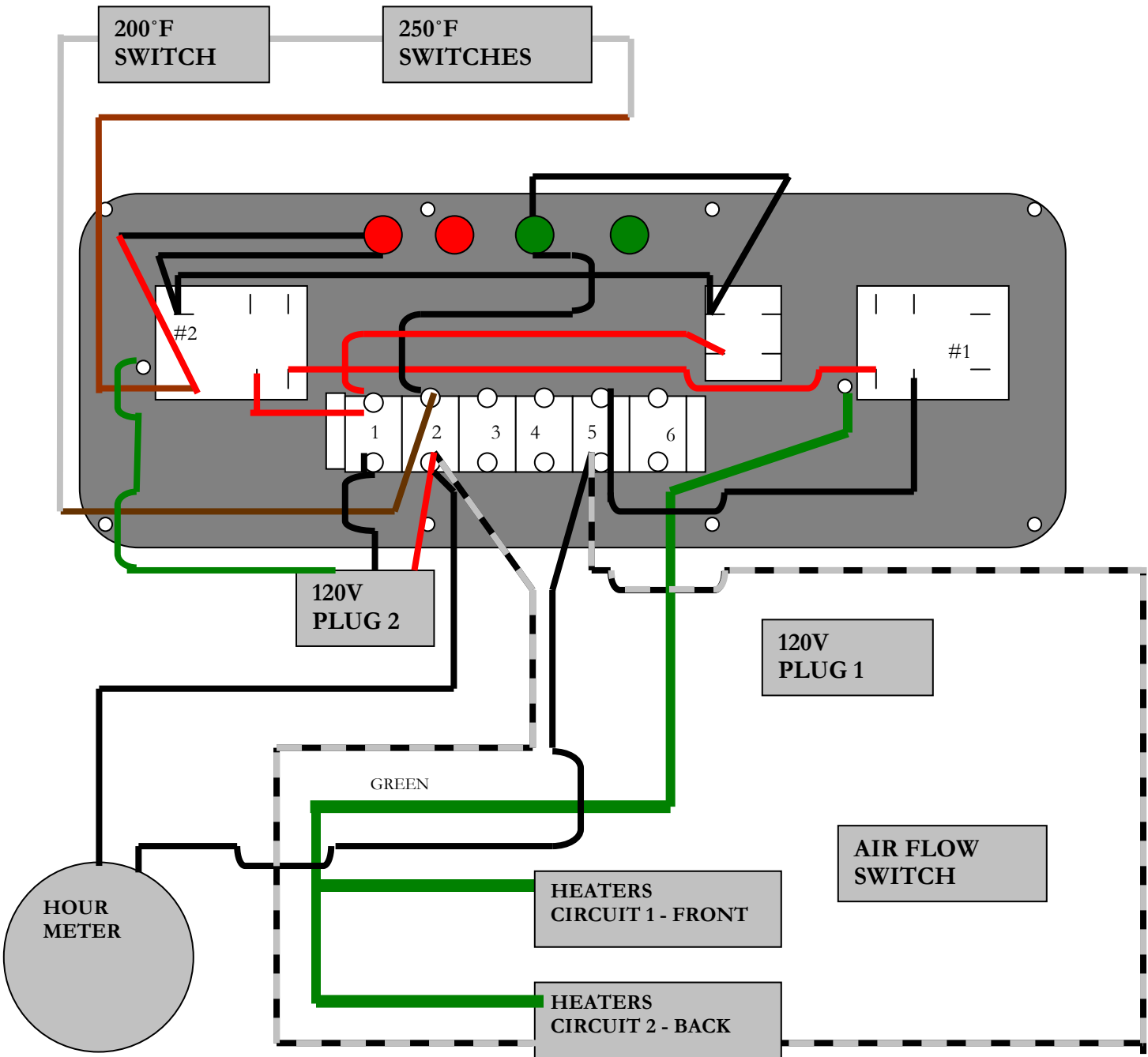

Relay #1 coil – 120vac  
 Relay #2 coil – 120vac  
 (Coil Terminals are #1 & #0)

